

electric*Q*

USER MANUAL

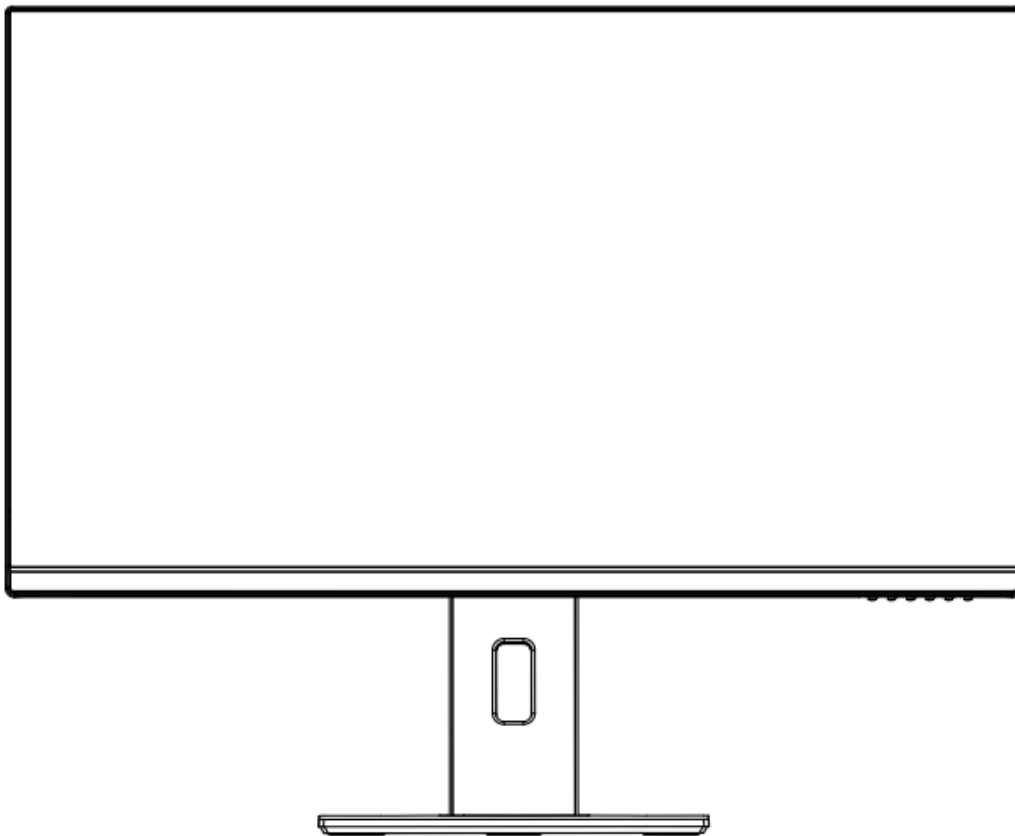

28 INCH LED MONITOR

eiQ-284K144FSGH

Thank you for choosing electricQ
Please read the user manual before using this monitor and keep it safe for future reference
Visit www.electriQ.co.uk to view our entire range of Intelligent Electricals

SETTLING IN OK?

We hope this has been helpful to you.

We would love to see how you're getting on with your new purchase, so please share any snaps you have on the platform of your choice below.

Our community awaits your uploads - Snap, tag and hashtag away!



@electriQUK

#electriQUK

WE'RE HERE TO HELP

Should you have any problems or questions with your purchase, please contact a member of our customer service team.

☎ 0330 390 3061

✉ support@electriQ.co.uk

Mon-Fri | 9am to 5pm

Unit J6, Lowfields Business Park,
Lowfields Way, Elland
West Yorkshire, HX5 9DA

CONTENTS

SAFETY INFORMATION	4
WHAT'S INCLUDED	6
QUICK START GUIDE	6
STAND INSTALLATION	7
CONNECTIONS AVAILABLE ON THE MONITOR	8
INITIAL SETUP	9
MENU OPTIONS	9
OSD MENU	10
INPUT	10
PICTURE	10
COLOUR	11
ADVANCED	12
ULTRA HDR	12
AUDIO	13
QUICK LINK	13
OTHER	14
SPECIFICATION	15
TROUBLESHOOTING	16
SUPPORT	16

SAFETY INFORMATION

- Read these instructions - All the safety and operating instructions should be read before this product is operated.
- Keep these instructions - The safety and operating instructions should be retained for future reference.
- Heed all warnings - All warnings on the appliance and in the operating instructions should be adhered to.
- Follow all instructions - All operating and usage instructions should be followed.
- Do not use this equipment near water, or in humid environments - The appliance should not be used near water or moisture e.g. in a wet basement or near a swimming pool.
- Clean only with a dry cloth. Do not use solvents or petroleum-based fluids.
- Do not block any ventilation openings.
- Do not install near any heat sources such as radiators, stoves or other apparatus (including amplifiers) that produce heat.
- Do not tamper with the supplied plug. This plug is a BS1363 standard plug.
- Protect the power cord from being walked on or trapped, particularly at the plug and at the point where it exits from the appliance.
- Only use attachments/accessories specified by the manufacturer.
- Use only with a cart, stand, tripod, bracket or table specified by the manufacturer or sold with the apparatus. When a cart or stand is used, use caution when moving it to avoid any injuries or damage from it tipping over.
- Unplug the apparatus during lightning storms or when unused for long periods of time.
- Refer all servicing to qualified personnel. Servicing is required when the apparatus has been damaged in any way, such as if the power supply cord or plug is damaged, liquid has been spilled or objects have fallen into the apparatus or it has been exposed to rain or moisture, it does not operate normally or has been dropped.
- Please keep the unit in a well-ventilated environment.
- The monitor should only be connected to a mains power supply as rated on the back of the equipment.
- To prevent overload, do not share the same power supply socket with too many other electronic components.
- Do not place any connecting wires where they may be stepped on or tripped over.
- Do not place heavy items on the cable as this may cause damage.
- When removing from a socket hold by the plug and not the wires.
- Disconnect the power immediately and seek professional help if the plug or cable is damaged, liquid has spilt onto the unit, if accidentally exposed to water or moisture, if anything accidentally penetrates the ventilation slots or if

the unit does not work normally.

- Do not remove the safety covers. There are no user serviceable parts inside. Trying to service the unit yourself is dangerous and may invalidate the product's warranty. Only qualified personnel should service this apparatus.
- Do not block ventilation slots on the back cover. The monitor can be placed in a cabinet but ensure at least 5cm (2") clearance all around. Do not tap or shake the screen, this may damage internal components.
- Due to our continuous product development, the operation and or features of the product received may vary slightly from the information provided within the manual.
- **WARNING:** To reduce the risk of fire or electric shock, do not expose this apparatus to rain or moisture. The apparatus shall not be exposed to dripping or splashing and objects filled with liquids, such as vases, shall not be placed on the apparatus.
- **WARNING:** The wall plug socket is used as a disconnection device and should remain readily accessible.
- Although every effort is made to maintain the accuracy of the manual, due to continuous product development, some variation from the manual is possible.
- The availability of features and settings may vary depending on the input source, method of connection as well as the quality and specification of the cables used.



AT FULL VOLUME, PROLONGED LISTENING MAY DAMAGE THE USER'S HEARING.



This warning sign is to warn of dangerous voltage inside the product.



CAUTION: To reduce the risk of electric shock, **DO NOT** remove the cover (or back). No user serviceable parts inside. Refer servicing to qualified service personnel.



This warning sign is to alert you of important instructions accompanying the product.

WHAT'S INCLUDED



USER MANUAL

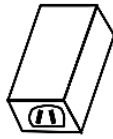

POWER SUPPLY

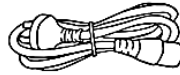

POWER CABLE

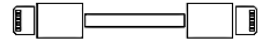

HDMI



USB-A to B

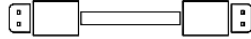

USB-C

PRODUCT DIAGRAM

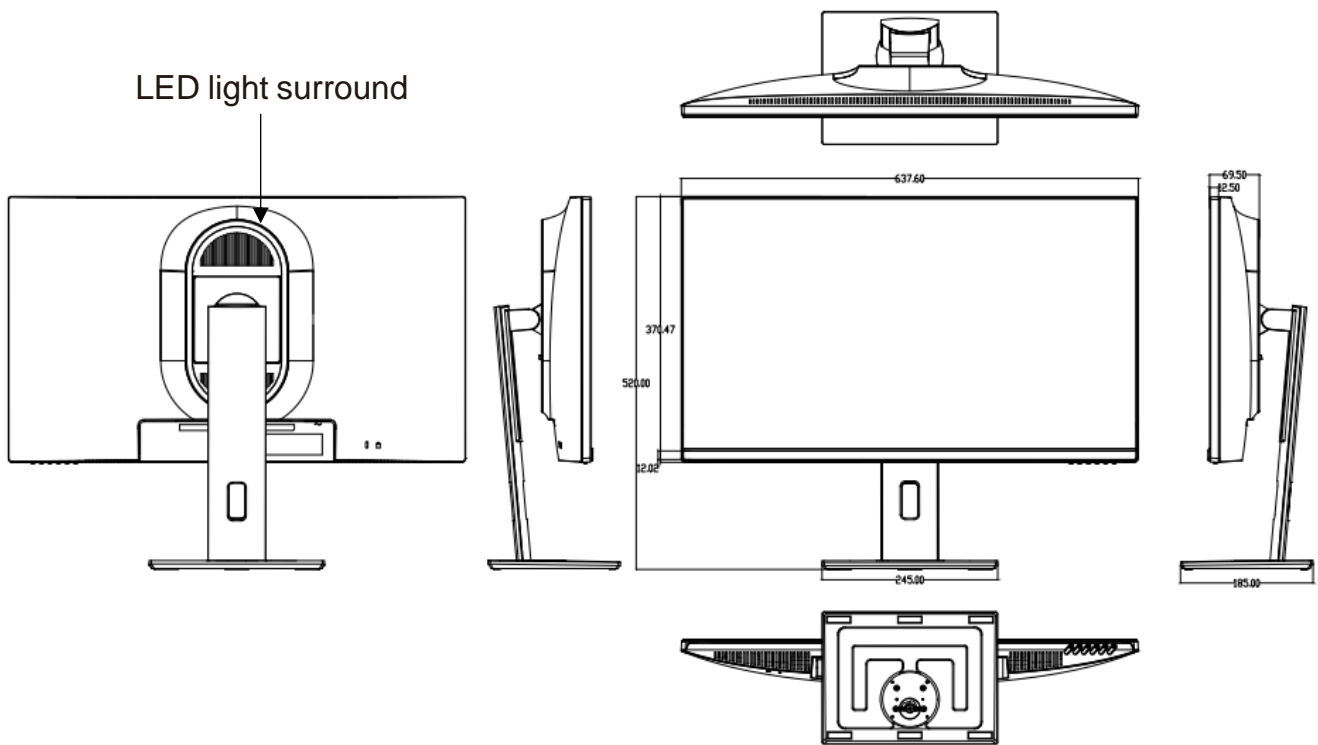

QUICK START GUIDE

- Due to the heavy weight and dimensions of the LCD screens and their fragile nature, we recommend that they are unpacked and assembled by 2 people.
- electriQ and its distributors and dealers are not liable or responsible for damage or injury caused by improper installation, improper use or failure to observe these safety instructions. In such cases any guarantee will expire. The stand can be removed from the rear of the monitor by pressing the quick release button on the rear of the monitor.

STAND ASSEMBLY

1

Open the package, take out the Styrofoam and place it flat on a table. Remove the upper foam, remove the film bag from the monitor, and place the display on the lower foam.

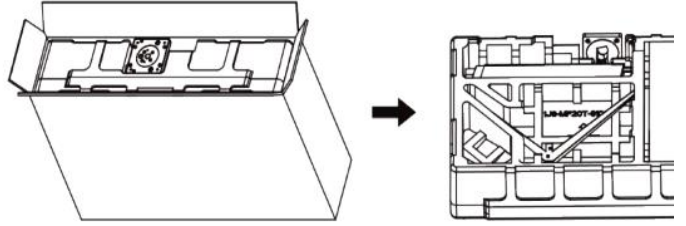

2

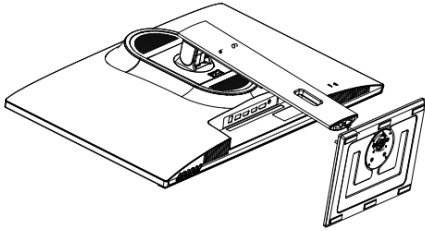

Insert the base and screw securely into place.

3

Insert the valve stem into the slot of the back cover.

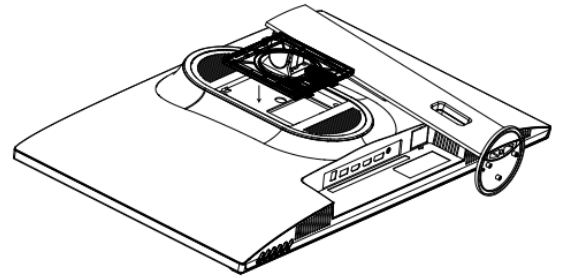

4

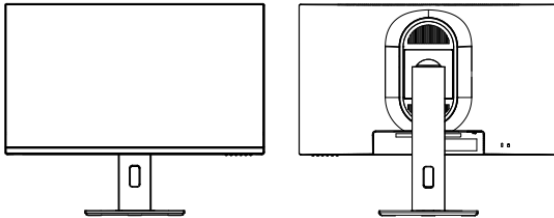

Carefully hold the stand while lifting the monitor to an upright position (Note: During the process of standing up the monitor, please do not pinch the screen directly with your hand to prevent the screen from breaking)

STAND REMOVAL

1

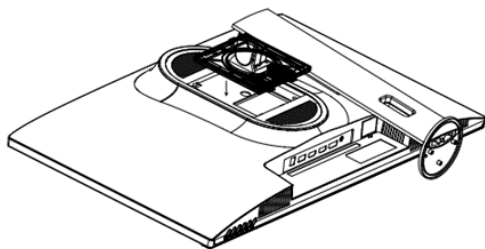

Press the button on the column board and push up for removal.

ADJUSTING THE STAND

The stand allows full adjustment of the screen position. The height of the monitor can be adjusted by holding the sides of the casing and sliding the screen up and down on the stand.

The screen can also be tilted and twisted.

With the monitor at the highest position on the stand, the screen can also be rotated by 90 degrees to view in portrait mode.

When adjusting the monitor, be careful not to put pressure on the screen as this may cause damage.

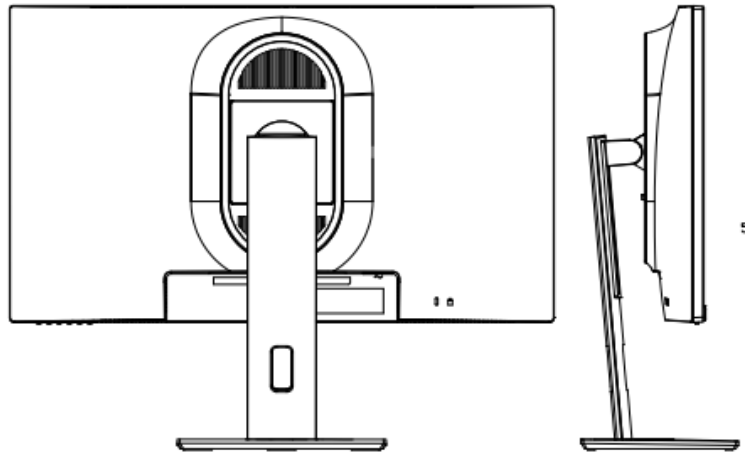

WALL MOUNTING

- The monitor is provided with mounting holes for a VESA approved wall mounting bracket (not supplied).
- The VESA mounting pattern is: 100x100mm and the size of the screws is BM4*10mm (not supplied)
- Do not use screws longer than specified or damage will occur to the internal components.

Note: the monitor is heavy, only a competent person such as a professional installer should attempt the installation. Only a suitable TV should be hung on the mount and mount should not be installed more than 2m above the ground

CONNECTIONS AVAILABLE ON THE MONITOR

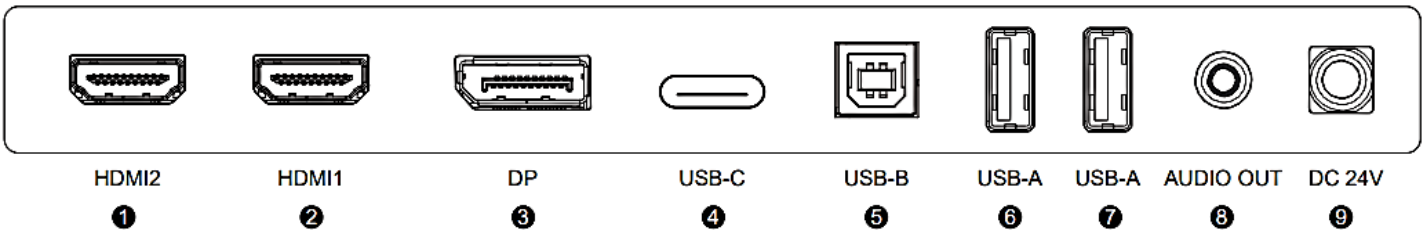

1	HDMI 2 (2.1)	Max 4K @ 120Hz
2	HDMI 1 (2.1)	Max 4K @ 120Hz
3	DP (1.4)	Max 4K @ 144Hz
4	USBC	Max 4K @ 144Hz
5	USB – B	Max resolutions / refresh rates will be dependant on the equipment connected and cables used.
6	USB – A	
7	USB – A	
8	Audio out	
9	DC 24 v	

NOTE: Both USB – A ports can be used for connecting devices such as a mouse or a keyboard to your computer and do not require any further cables when connecting to a USB-C source. When using the HDMI or DP inputs, the USB-B cable must be attached between the computer and monitor to allow their use.

GETTING STARTED

MONITOR CONTROLS

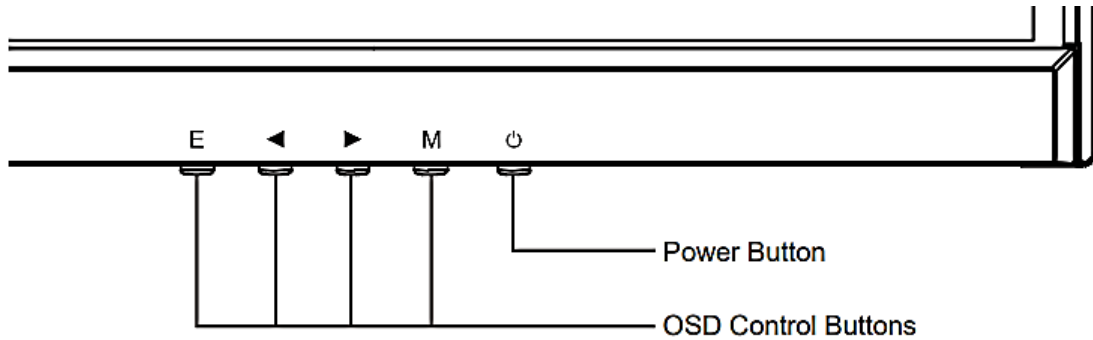

E	Select the signal source or Exit the On-Screen Display (OSD)
◀	Go Up within the OSD Menu and increase the value of a selected item
▶	Go Down within the OSD Menu and decrease the value of a selected item
M	Open the OSD Menu, use to select the highlighted option within the menu
Power	Turn the monitor on or off

INITIAL SETUP

1. Connect the monitor to a power outlet using the supplied adaptor.
2. Press the power button on the monitor or to turn it on (The indicator will be blue).
3. Connect the relevant cable to the corresponding input on the monitor. The source will be automatically detected.
4. To change between inputs, press the SOURCE button to enter the source menu. Use the ▲ and ▼ buttons to choose the input source between Auto Select, TYPEC, DP, HDMI1, and HDMI2.



MENU OPTIONS

The menu for the monitor can be accessed by pressing the menu button on the control panel. The menu is separated into the following sub menus: INPUT SOURCE, PICTURE, COLOUR SETTINGS, ADVANCE SETTINGS, ULTRA HDR, AUDIO, QUICK LINK, OTHER. Details of each menu can be found in the following section.

**OSD MENU
INPUT SOURCE**



Signal | Switch the signal input or select the source between Type C, DP, HDMI1, HDMI2.

PICTURE

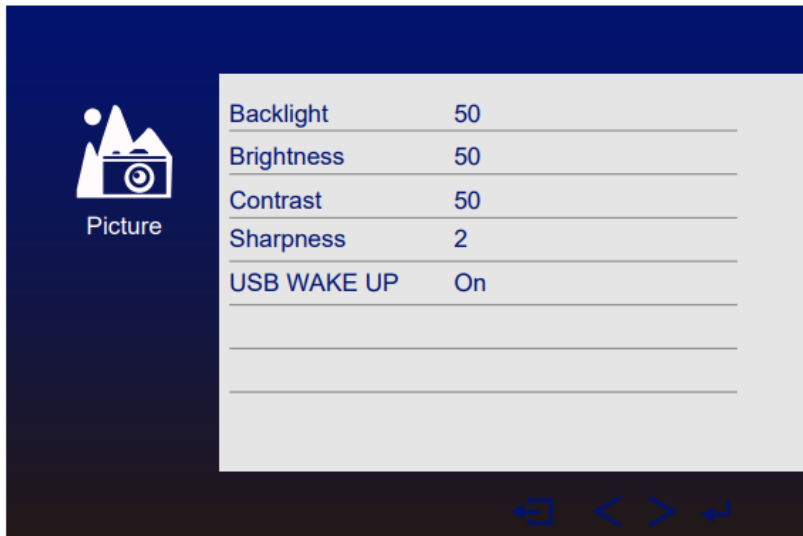

Brightness	Adjust the brightness of the display between 0 and 100.
Contrast	Adjust the contrast of the display between 0 and 100.
Sharpness	Adjust the sharpness value between 0-4.
Backlight	Adjust the backlight of the display between 0 and 100.
USB wake up	Turn on or off USB wake up.

COLOUR SETTINGS

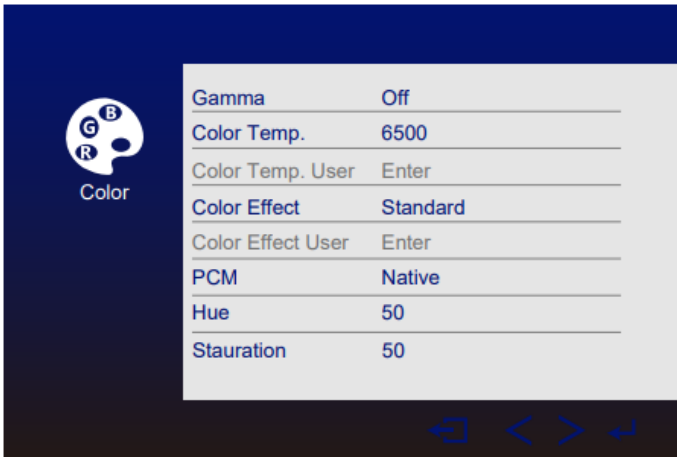

WHAT IT MEANS:

Gamma – Affects the brightness / appearance of darker areas of the image.

PCM – Chooses the colour management system used, which affects the colours displayed on the monitor.

Gamma	Change the display Gamma value to: Off, 1.8, 2.0, 2.2, 2.4.
Colour Temp	Change the colour Temp to 6500, 7500, 5800, 9300, sRGB, User.
Colour Effect	Change the Colour Effect to Standard, Game, Movie, Photo, Vivid, User.
PCM	Change PCM to native, Adobe RGB, sRGB, User.
Hue	Change the Hue value between 0 and 100.
Saturation	Change the Saturation of the display between 0 and 100.

ADVANCE SETTINGS

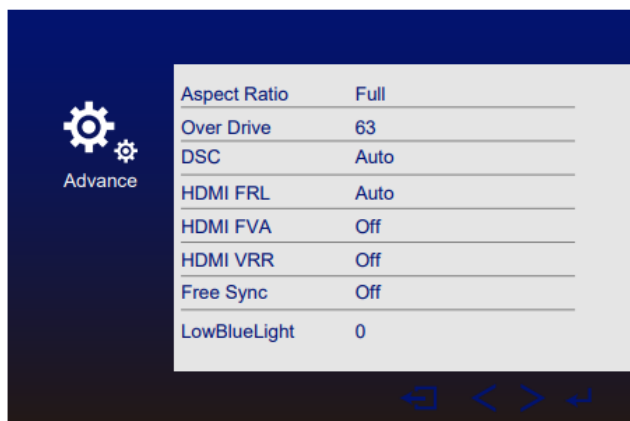

WHAT IT MEANS:

Overdrive – Increases the speed of the monitors response to reduce ghosting of fast moving objects

Display Stream Compression – Visually lossless compression to reduce the bandwidth demand when showing high definition content

Fixed Rate Link – Designed to allow higher uncompressed resolutions.

Fast V-Active – Allows the video card to increase the character rate to increase the speed of data transmission to reduce lag.

Variable refresh rate – Allows the monitor to adjust its refresh rate in real time to match the output.

Freesync – reduces tearing and stuttering on fast moving games.

Aspect Ratio	Change the Aspect Ratio to full, 16:9, 4:3, 1:1, 5:4, reduce, enlarge.
Over Drive	Change the over drive from 0-127.
DSC	Turn Display Stream Compression to auto or off.
HDMIFRL	Turn Fixed Rate Link to auto or off.
HDMIFVA	Turn the Fast V-active to auto or off.
HDMIVRR	Turn Variable Refresh Rate to auto or off.
Free Sync	Turn on or off Free Sync.
Low Blue Light	Change the Low Blue Light value from 0-100.

ULTRA HDR

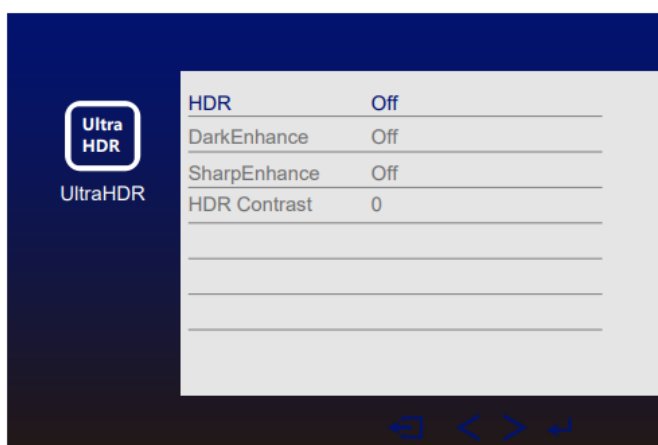

WHAT IT MEANS:

HDR (High dynamic range) – Provides brighter highlights and a wider range of colour details to improve the quality of the image.

HDR	Change the HDR to Off, Auto, Forcest, 2084.
Dark Enhance	Turn on or off Dark Enhance function.
Sharp Enhance	Turn on or off Sharp Enhance function.
HDR Contrast	Change HDR Contrast value from 0-100.

AUDIO

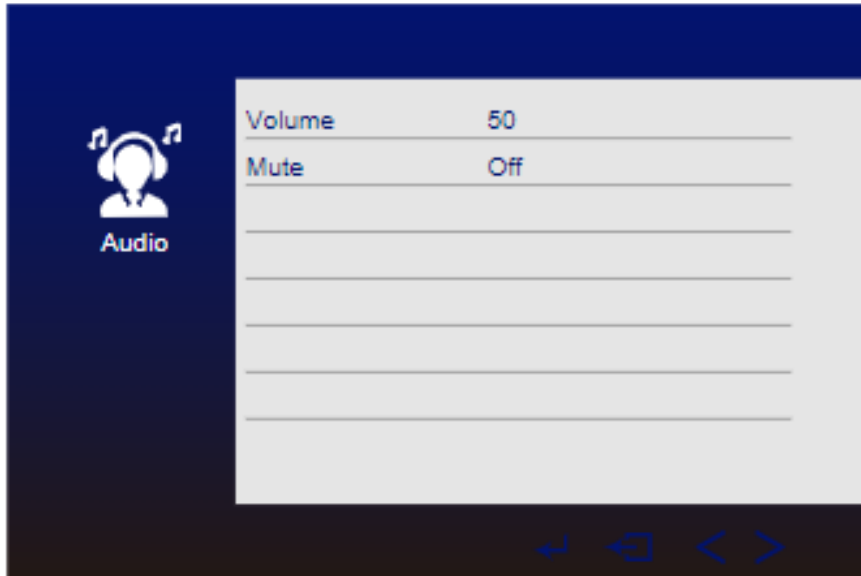

Mute	Turn On and off to mute and unmute the audio output.
Volume	Adjust the output volume between 0 and 100.

QUICK LINK

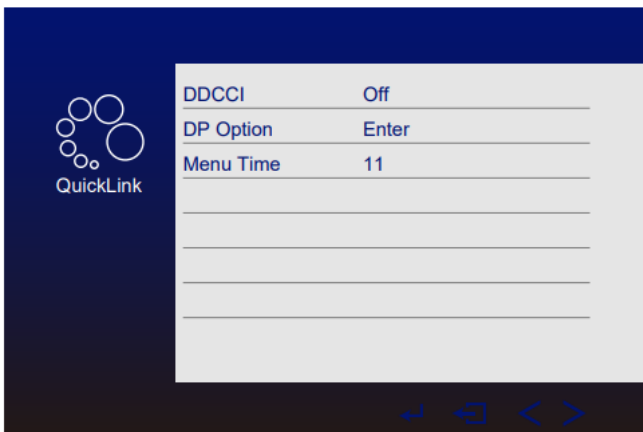

WHAT IT MEANS:

DDCCI – Allows communication between the monitor and computer, providing the computer with information about the monitors supported modes, and allows the computer to make changes to certain settings.

DDCCI	Turn on or off DDCCI
DP Option	Choose the DP source from D1 and D2
Menu Time	Change how long the menu is displayed from 0-60

OTHER

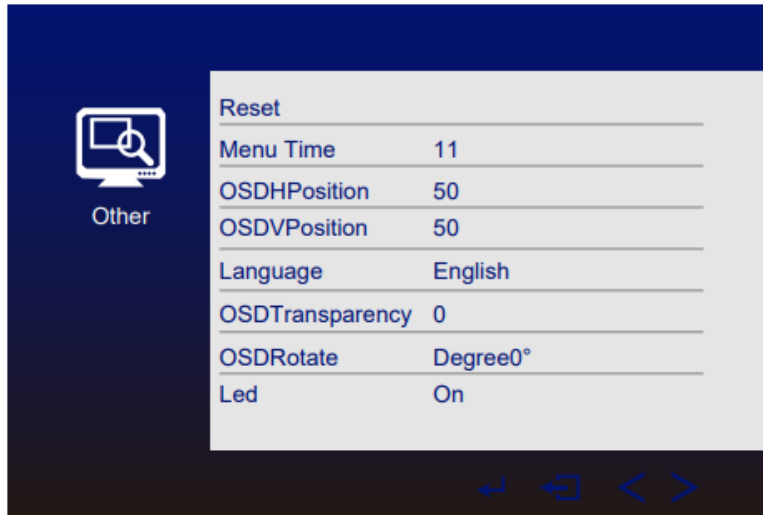

Reset	Restore factory default setting Menu Time
Menu Time	Adjust the time that OSD menu will display on the screen.
OSD V Position	Change the vertical position of the OSD Menu.
OSD H Position	Adjust the horizontal position of the OSD Menu.
Language	Change the OSD Menu display language.
OSD Transparency	Change the OSD Transparency value from 0-100.
OSD Rotate	Rotate the OSD Menu.
LED	Turn the rear LED on or off.

SPECIFICATION

eiQ-284K144FSGH	
Panel Type	28" (16:9) LED Backlit Monitor
Panel Dimensions	631.93mm Diagonal
Monitor Dimensions	638x530x185 (With Stand) 638x370x72mm (W/O Stand)
Wall Mountable	Yes – VESA 100 x 100
Case Type	Matte Black
Max Resolution	3840(H)x2160(V)@144Hz HDMI2.1 supports 4K @ 120Hz. DP1.4 supports 4K @ 144Hz.
Active Display Area	620.928(H)x341.28(V)
Pixel Pitch	0.160(H)x0.160(V)
Contrast Ratio	1000:1 Typical
Brightness	400 cd/m ²
HDR	Yes – HDR400
Response Time	7Ms GTG and 1ms MPRT
Viewing Angle	178°/178° CR≥10
Display Colours	1.06B (10 bit)
Video Compatibility	Multi-Standard for NTSC / PAL
Aspect Ratio	16:9
Speaker Multimedia Speakers	2x3W
Sound Demodulation	Stereo. Audio
Operating Humidity	20%-70%
Operating Temperature	-10 to 50°C
IN/OUT INTERFACE	
Video Interface	HDMI (2.1) x2, DP (1.4) x1, USB-Cx1
Audio Interface	Audio out x1
KVM Connections	1 x USB-B (To computer), 2 x USB-A (To devices) – Supports 65W PD for charging
Stand Type	Desktop
Button Position	Right Hand Side
Power Input	DC 24V 5A
Power Consumption	≤53W

TROUBLESHOOTING

Problem	Solution
No power	Insert the plug securely into the power outlet.
No picture	Ensure that the equipment is connected properly.
	Ensure the correct input is selected.
Buttons on the monitor don't do anything	Disconnect the power plug and then reconnect it. (The unit may not be operating properly due to lightning, static, or other factors.)
Noise or other interference	Electronic equipment near the unit may be causing interference. Relocate the unit or move the equipment.

ENVIRONMENTAL PROTECTION



Recycling facilities are now available for all customers at which you can deposit your old electrical products. Customers will be able to take any old electrical equipment to participating civic amenity sites run by their local councils. Please remember that this equipment will be further handled during the recycling process, so please be considerate when depositing your equipment. Please contact the local council for details of your local household waste recycling centres

electriQ UK SUPPORT

www.electriQ.co.uk/support

If the unit fails to operate call: 0330 390 3061 or complete the online form

Office hours: 9AM- 5PM Monday to Friday

www.electriQ.co.uk
Unit J6, Lowfields Business Park
Lowfields Way, Elland
West Yorkshire, HX5 9DA